

Association Connecting Electronics Industries



IPC-7711B/7721B

Rework, Modification and Repair of Electronic Assemblies

Developed by the Repairability Subcommittee (7-34) of the Product Assurance Committee (7-30) of IPC

Supersedes:
IPC-7711A/7721A -
October 2003
IPC-R-700C -
January 1988

Users of this publication are encouraged to participate in the development of future revisions.

Contact:



IPC
3000 Lakeside Drive, Suite 309S
Bannockburn, Illinois
60015-1249
Tel 847 615.7100
Fax 847 615.7105

Table of Contents





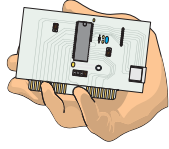

PART 1 General Information and Common Procedures

1 General	1	1.8.7 Preheating (Auxiliary) Heating	5
1.1 Scope	1	1.8.8 Hand Held Drilling and Grinding Tool	5
1.2 Purpose	1	1.8.9 Precision Drill/Mill System	5
1.2.1 Definition of Requirements	1	1.8.10 Eyelets and Eyelet Press System	5
1.3 Background	1	1.8.11 Gold Plating System	5
1.4 Terms and Definitions	1	1.8.12 Tools and Supplies	5
1.4.1 Class of Product	1	1.8.13 Materials	6
1.4.2 Board Types	2	1.8.13.1 Solder	6
1.4.3 Skill Level	2	1.8.13.2 Flux	6
1.5 Applicability, Controls and Acceptability	2	1.8.13.3 Replacement Conductors and Lands	6
1.5.1 Level of Conformance	2	1.8.13.4 Epoxy and Coloring Agents	6
1.5.1.1 Levels of Conformance	2	1.8.13.5 Adhesives	6
1.5.2 Compliance	3	1.8.13.6 General	6
1.6 Training	3	1.8.14 Process Goals and Guidelines	6
1.7 Basic Considerations	4	1.8.14.1 Nondestructive Component Removal	6
1.8 Workstations, Tools, Materials and Processes	4	1.8.14.1.1 Surface Mount Components	6
1.8.1 ESD/EOS Controls	4	1.8.14.1.2 Through-Hole Components	7
1.8.2 Vision Systems	4	1.8.14.1.3 Component Removal Using Solder Fountain Method	7
1.8.3 Lighting	4	1.8.14.2 Component Installation	7
1.8.4 Fume Extraction	4	1.8.14.2.1 Land Preparation	7
1.8.5 Tools	4	1.8.14.2.2 Surface Mount Components	7
1.8.6 Primary Heating Methods	4	1.8.14.2.3 Through-Hole Components	7
1.8.6.1 Conductive (by contact) Heating Methods	4	1.8.15 Cleaning Station/System	7
1.8.6.2 Convective (hot gas) and IR (radiant) Heating Methods	5	1.8.16 Component Removal and Installation	7
		1.8.17 Conformal Coating Area	7
		1.8.18 Selecting a Process	7
		1.8.19 Time Temperature Profile (TTP)	8
		1.9 Lead Free	8



Handling/Cleaning

Procedure	Description	Illustration	Product Class	Skill Level	Level of Conformance
2.1	Handling Electronic Assemblies		N/A	N/A	N/A
2.2	Cleaning		N/A	N/A	N/A

Coating Removal

Procedure	Description	Illustration	Product Class	Skill Level	Level of Conformance
2.3.1	Coating Removal, Identification of Conformal Coating		R, F, W, C	Advanced	High
2.3.2	Coating Removal, Solvent Method		R, F, W, C	Advanced	High
2.3.3	Coating Removal, Peeling Method		R, F, W, C	Advanced	High
2.3.4	Coating Removal, Thermal Method		R, F, W, C	Advanced	High
2.3.5	Coating Removal, Grinding/Scraping Method		R, F, W, C	Advanced	High
2.3.6	Coating Removal, Micro Blasting Method		R, F, W, C	Advanced	High

Coating Replacement

Procedure	Description	Illustration	Product Class	Skill Level	Level of Conformance
2.4.1	Coating Replacement, Solder Resist		R, F, W, C	Intermediate	High
2.4.2	Coating Replacement, Conformal Coatings/Encapsulants		R, F, W, C	Intermediate	High

Conditioning

Procedure	Description	Illustration	Product Class	Skill Level	Level of Conformance
2.5	Baking and Preheating		R, F, W, C	Intermediate	High

Epoxy Mixing and Handling

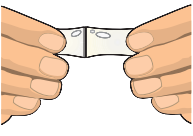
Procedure	Description	Illustration	Product Class	Skill Level	Level of Conformance
2.6	Epoxy Mixing and Handling		R, F, W, C	Intermediate	High

Legends/Markings

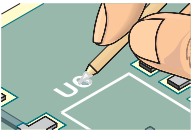
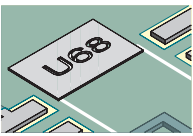
Procedure	Description	Illustration	Product Class	Skill Level	Level of Conformance
2.7.1	Legend/Marking, Stamping Method		R, F, W, C	Intermediate	High
2.7.2	Legend/Marking, Hand Lettering Method		R, F, W, C	Intermediate	High
2.7.3	Legend/Marking, Stencil Method		R, F, W, C	Intermediate	High

Tip Care and Maintenance

Procedure	Description	Illustration	Product Class	Skill Level	Level of Conformance
2.8	Tip Care and Maintenance		N/A	N/A	N/A

Table of Contents

PART 2 Rework

3 Removal

3.1 Through-Hole Desoldering

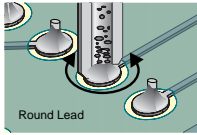
Procedure	Description		Product Class	Skill Level	Level of Conformance
3.1.1	Continuous Vacuum Method		R,F,W	Intermediate	High
3.1.2	Continuous Vacuum Method - Partial Clinch		R,F,W	Intermediate	High
3.1.3	Continuous Vacuum Method - Full Clinch		R,F,W	Intermediate	High
3.1.4	Full Clinch Straightening Method		R,F,W	Intermediate	High
3.1.5	Full Clinch Wicking Method		R,F,W	Advanced	High

3.2 PGA and Connector Removal

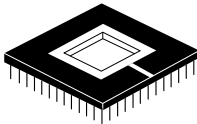
Procedure	Description		Product Class	Skill Level	Level of Conformance
3.2.1	Solder Fountain Method		R,F,W,C	Expert	Medium

3.3 Chip Component Removal

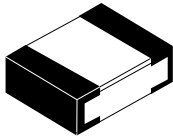
Procedure	Description		Product Class	Skill Level	Level of Conformance
3.3.1	Bifurcated tip		R,F,W,C	Intermediate	High
3.3.2	Tweezer Method		R,F,W,C	Intermediate	High
3.3.3	Bottom Termination - Hot Air Method		R,F,W,C	Intermediate	High

3.4 Leadless Component Removal

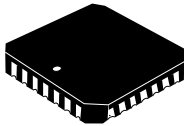
Procedure	Description		Product Class	Skill Level	Level of Conformance
3.4.1	Solder Wrap Method		R,F,W,C	Advanced	High
3.4.2	Flux Application Method		R,F,W,C	Advanced	High
3.4.3	Hot Gas (Air) Reflow Method		R,F,W,C	Advanced	High

3.5 SOT Removal

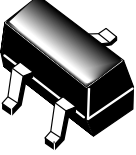
Procedure	Description		Product Class	Skill Level	Level of Conformance
3.5.1	Flux Application Method		R,F,W,C	Intermediate	High
3.5.2	Flux Application Method - Tweezer		R,F,W,C	Intermediate	High
3.5.3	Hot Air Pencil		R,F,W,C	Intermediate	High

3.6 Gull Wing Removal (two sided)

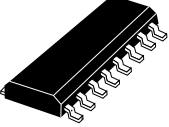
Procedure	Description		Product Class	Skill Level	Level of Conformance
3.6.1	Bridge Fill Method		R,F,W,C	Intermediate	High
3.6.2	Solder Wrap Method		R,F,W,C	Intermediate	High
3.6.3	Flux Application Method		R,F,W,C	Intermediate	High
3.6.4	Bridge Fill Method - Tweezer		R,F,W,C	Advanced	High
3.6.5	Solder Wrap Method - Tweezer		R,F,W,C	Advanced	High
3.6.6	Flux Application Method - Tweezer		R,F,W,C	Advanced	High

3.7 Gull Wing Removal (four sided)

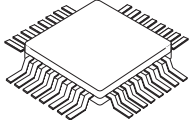
Procedure	Description		Product Class	Skill Level	Level of Conformance
3.7.1	Bridge Fill Method - Vacuum Cup		R,F,W,C	Advanced	High
3.7.1.1	Bridge Fill Method - Surface Tension		R,F,W,C	Intermediate	High
3.7.2	Solder Wrap Method - Vacuum Cup		R,F,W,C	Advanced	High
3.7.2.1	Solder Wrap Method - Surface Tension		R,F,W,C	Intermediate	High
3.7.3	Flux Application Method - Vacuum Cup		R,F,W,C	Advanced	High
3.7.3.1	Flux Application Method - Surface Tension		R,F,W,C	Intermediate	High
3.7.4	Bridge Fill Method - Tweezer		R,F,W,C	Advanced	High
3.7.5	Solder Wrap Method - Tweezer		R,F,W,C	Advanced	High
3.7.6	Flux Application Method - Tweezer		R,F,W,C	Advanced	High
3.7.7	Hot Gas Reflow Method		R,F,W,C	Advanced	High

3.8 J-Lead Removal

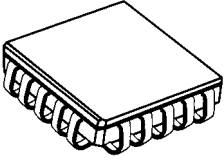
Procedure	Description		Product Class	Skill Level	Level of Conformance
3.8.1	Bridge Fill Method - Tweezer		R,F,W,C	Advanced	High
3.8.1.1	Bridge Fill Method - Surface Tension		R,F,W,C	Advanced	High
3.8.2	Solder Wrap Method - Tweezer		R,F,W,C	Advanced	High
3.8.2.1	Solder Wrap Method - Surface Tension		R,F,W,C	Advanced	High
3.8.3	Flux Application Method - Tweezer		R,F,W,C	Advanced	High
3.8.4	Flux & Tin Tip Only		R,F,W,C	Advanced	High
3.8.5	Hot Gas Reflow System		R,F,W,C	Advanced	High

3.9 BGA/CSP Removal

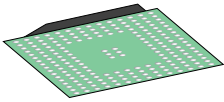
Procedure	Description		Product Class	Skill Level	Level of Conformance
3.9.1	Hot Gas Reflow System		R,F,W,C	Advanced	High
3.9.2	Vacuum Method		R,F,W,C	Advanced	Medium

3.10 PLCC Socket Removal

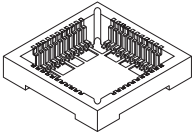
Procedure	Description		Product Class	Skill Level	Level of Conformance
3.10.1	Bridge Fill Method		R,F,W,C	Advanced	High
3.10.2	Solder Wrap Method		R,F,W,C	Advanced	High
3.10.3	Flux Application Method		R,F,W,C	Advanced	High
3.10.4	Hot Air Pencil Method		R,F,W,C	Advanced	Medium

4 Pad/Land Preparation

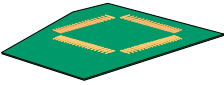
Procedure	Description		Product Class	Skill Level	Level of Conformance
4.1.1	Surface Mount Land Preparation - Individual Method		R,F,W,C	Intermediate	High
4.1.2	Surface Mount Land Preparation - Continuous Method		R,F,W,C	Intermediate	High
4.1.3	Surface Solder Removal - Braid Method		R,F,W,C	Intermediate	High
4.2.1	Pad Releveling - Using Blade Tip		R,F,W,C	Intermediate	High
4.3.1	SMT Land Tinning - Using Blade Tip		R,F,W,C	Intermediate	Medium
4.4.1	Cleaning SMT Lands - Using Blade Tip and Solder Braid		R,F,W,C	Intermediate	High

5 Installation

5.1 Through-Hole Installation

Procedure	Description	
	Install following the requirements of J-STD-001 and J-HDBK-001	

5.2 PGA and Connector Installation

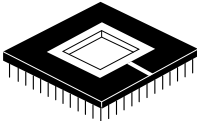
Procedure	Description		Product Class	Skill Level	Level of Conformance
5.2.1	Solder Fountain Method with PTH Prefilled		R,F,W,C	Expert	Medium

5.3 Chip Installation

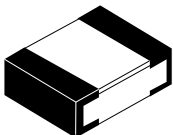
Procedure	Description		Product Class	Skill Level	Level of Conformance
5.3.1	Solder Paste Method/Hot Air Pencil		R,F,W,C	Intermediate	High
5.3.2	Point-to-Point Method		R,F,W,C	Intermediate	High

5.4 Leadless Component Installation

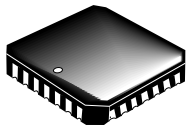
Procedure	Description		Product Class	Skill Level	Level of Conformance
5.4.1	Hot Gas (Air) Reflow Method		R,F,W,C	Advanced	High

5.5 Gull Wing Installation

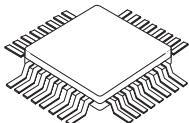
Procedure	Description		Product Class	Skill Level	Level of Conformance
5.5.1	Multi-Lead Method - Top of Lead		R,F,W,C	Advanced	High
5.5.2	Multi-Lead Method - Toe Tip		R,F,W,C	Advanced	High
5.5.3	Point-to-Point Method		R,F,W,C	Intermediate	High
5.5.4	Solder Paste Method/Hot Air Pencil		R,F,W,C	Advanced	High
5.5.5	Hook Tip w/Wire Layover		R,F,W,C	Intermediate	High
5.5.6	Blade Tip with Wire		R,F,W,C	Advanced	Medium

5.6 J-Lead Installation

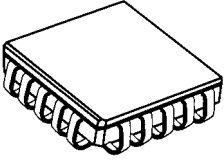
Procedure	Description	Product Class	Skill Level	Level of Conformance
				
5.6.1	Solder Wire Method	R,F,W,C	Advanced	High
5.6.2	Point-to-Point Method	R,F,W,C	Intermediate	High
5.6.3	Solder Paste Method/Hot Air Pencil	R,F,W,C	Advanced	High
5.6.4	Multi-Lead Method	R,F,W,C	Intermediate	High

5.7 BGA/CSP Installation

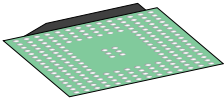
Procedure	Description	Product Class	Skill Level	Level of Conformance
				
5.7.1	Using Solder Wire to Prefill Lands	R,F,W,C	Advanced	High
5.7.2	Using Solder Paste to Prefill Lands	R,F,W,C	Advanced	High
5.7.3	BGA Reballing Procedure - Fixture Method	R,C	Advanced	High
5.7.4	BGA Reballing Procedure - Paper Carrier Method	R,C	Advanced	High
5.7.5	BGA Reballing Procedure - Polyimide Stencil Method	R,C	Advanced	High

6 Removing Shorts

Procedure	Description	Product Class	Skill Level	Level of Conformance
				
6.1.1	J-Leads - Draw Off Method	R,F,W,C	Intermediate	High
6.1.2	J-Leads - Respread Method	R,F,W,C	Intermediate	High
6.1.2.1	J-Leads - Braid Method	R,F,W,C	Intermediate	High
6.1.3	Gull-Wing - Draw Off Method	R,F,W,C	Intermediate	High
6.1.4	Gull-Wing - Respread Method	R,F,W,C	Intermediate	High
6.1.4.1	Gull-Wing - Braid Method	R,F,W,C	Intermediate	High

Table of Contents

PART 3 Modification and Repair

Blisters and Delamination

Procedure	Description	Illustration	Product Class	Skill Level	Level of Conformance
3.1	Delamination/Blister Repair, Injection Method		R	Advanced	High

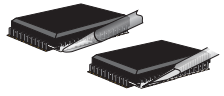
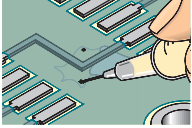
Bow & Twist

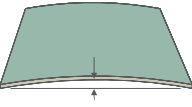
Procedure	Description	Illustration	Product Class	Skill Level	Level of Conformance
3.2	Bow and Twist Repair		R, W	Advanced	Medium

Hole Repair

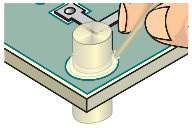
Procedure	Description	Illustration	Product Class	Skill Level	Level of Conformance
3.3.1	Hole Repair, Epoxy Method		R, W	Advanced	High
3.3.2	Hole Repair, Transplant Method		R, W	Expert	High

Key and Slot Repair

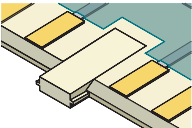
Procedure	Description	Illustration	Product Class	Skill Level	Level of Conformance
3.4.1	Key and Slot Repair, Epoxy Method		R, W	Advanced	High
3.4.2	Key and Slot Repair, Transplant Method		R, W	Expert	High

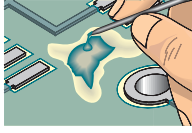
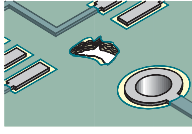
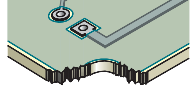

Base Material Repair

Procedure	Description	Illustration	Product Class	Skill Level	Level of Conformance
3.5.1	Base Material Repair, Epoxy Method		R, W	Advanced	High
3.5.2	Base Material Repair, Area Transplant Method		R, W	Expert	High
3.5.3	Base Material Repair, Edge Transplant Method		R, W	Expert	High

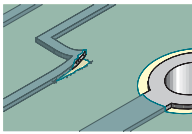
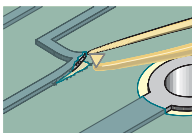
Lifted Conductors

Procedure	Description	Illustration	Product Class	Skill Level	Level of Conformance
4.1.1	Lifted Conductor Repair, Epoxy Seal Method		R, F	Intermediate	Medium
4.1.2	Lifted Conductor Repair, Film Adhesive Method		R, F	Intermediate	High

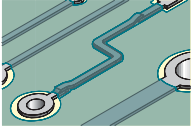
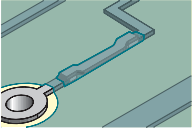
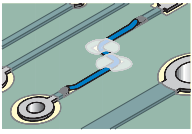
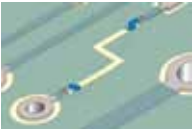
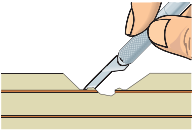

Conductor Repair

Procedure	Description	Illustration	Product Class	Skill Level	Level of Conformance
4.2.1	Conductor Repair, Foil Jumper, Epoxy Method		R, F, C	Advanced	Medium
4.2.2	Conductor Repair, Foil Jumper, Film Adhesive Method		R, F, C	Advanced	High
4.2.3	Conductor Repair, Welding Method		R, F, C	Advanced	High
4.2.4	Conductor Repair, Surface Wire Method		R, F, C	Intermediate	Medium
4.2.5	Conductor Repair, Through Board Wire Method		R	Advanced	Medium
4.2.6	Conductor Repair/Modification, Conductive Ink Method		R, F, C	Expert	Medium
4.2.7	Conductor Repair, Inner Layer Method		R, F	Expert	High

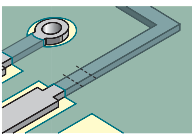
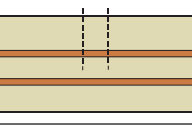
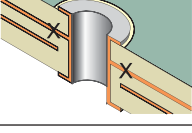
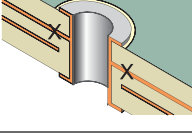
Conductor Cut

Procedure	Description	Illustration	Product Class	Skill Level	Level of Conformance
4.3.1	Conductor Cut, Surface Conductors		R, F	Advanced	High
4.3.2	Conductor Cut, Inner Layer Conductors		R, F	Advanced	High
4.3.3	Deleting Inner Layer Connection at a Plated Hole, Drill Through Method		R, F	Advanced	High
4.3.4	Deleting Inner Layer Connection at a Plated Hole, Spoke Cut Method		R, F	Advanced	High

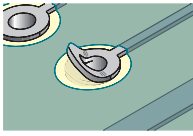
Lifted Land Repair

Procedure	Description	Illustration	Product Class	Skill Level	Level of Conformance
4.4.1	Lifted Land Repair, Epoxy Method		R, F	Advanced	Medium
4.4.2	Lifted Land Repair, Film Adhesive Method		R, F	Advanced	Medium

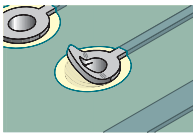
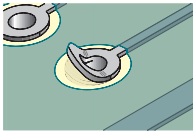

Land Repair

Procedure	Description	Illustration	Product Class	Skill Level	Level of Conformance
4.5.1	Land Repair, Epoxy Method		R, F	Advanced	Medium
4.5.2	Land Repair, Film Adhesive Method		R, F	Advanced	High

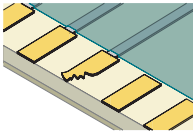
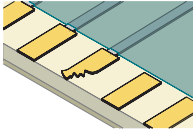
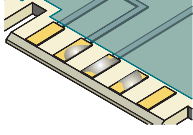
Edge Contact Repair

Procedure	Description	Illustration	Product Class	Skill Level	Level of Conformance
4.6.1	Edge Contact Repair, Epoxy Method		R, F, W, C	Advanced	Medium
4.6.2	Edge Contact Repair, Film Adhesive Method		R, F, W, C	Advanced	High
4.6.3	Edge Contact Repair, Plating Method		R, F, W, C	Advanced	High

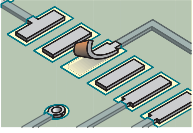
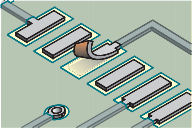

Surface Mount Pad Repair

Procedure	Description	Illustration	Product Class	Skill Level	Level of Conformance
4.7.1	Surface Mount Pad Repair, Epoxy Method		R, F, C	Advanced	Medium
4.7.2	Surface Mount Pad Repair, Film Adhesive Method		R, F, C	Advanced	High
4.7.3	Surface Mount, BGA Pad Repair, Film Adhesive Method		R, F, C	Advanced	High

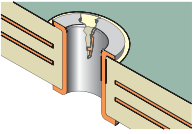
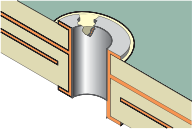
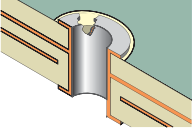
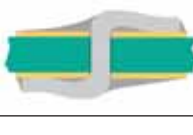
Plated Hole Repair

Procedure	Description	Illustration	Product Class	Skill Level	Level of Conformance
5.1	Plated Hole Repair, No Inner Layer Connection		R, F, W	Intermediate	High
5.2	Plated Hole Repair, Double Wall Method		R, F, W	Advanced	Medium
5.3	Plated Hole Repair, Inner Layer Connection		R	Expert	Medium
5.4	Plated Hole Repair, No Inner Layer Connection, Clinched Jumper Wire Method		R,F,W	Intermediate	Medium

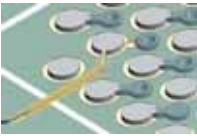
Jumpers

Procedure	Description	Illustration	Product Class	Skill Level	Level of Conformance
6.1	Jumper Wires		R, F, W, C	Intermediate	N/A
6.2.1	Jumper Wires, BGA Components, Foil Jumper Method		R, F	Expert	Medium
6.2.2	Jumper Wires, BGA Components, Through Board Method		R, F	Expert	High

Component Additions

Procedure	Description	Illustration	Product Class	Skill Level	Level of Conformance
6.3	Component Modifications and Additions		R, F, W, C	Advanced	N/A

Flexible Conductor Repair

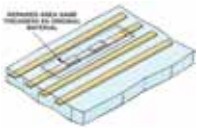
Procedure	Description	Illustration	Product Class	Skill Level	Level of Conformance
7.1.1	Flexible Conductor Repair		F	Expert	Medium

8 Wires**8.1 Splicing**

Procedure	Description	Illustration	Product Class	Skill Level	Level of Conformance
8.1.1	Mesh Splice		N/A	Intermediate	Low
8.1.2	Wrap Splice		N/A	Intermediate	Low
8.1.3	Hook Splice		N/A	Intermediate	Low
8.1.4	Lap Splice		N/A	Intermediate	Low

General Information and Common Procedures

1 General

1.1 Scope This document covers procedures for repairing and reworking printed board assemblies. It is an aggregate of information collected, integrated and assembled by the Repairability Subcommittee (7-34) of the Product Assurance Committee of the IPC. This revision includes expanded coverage for lead free processes, and additional inspection guidelines for operations such as repair that may not have other published criteria.

This document does not limit the maximum number of rework, modification or repair actions to a Printed Circuit Assembly.

1.2 Purpose This document prescribes the procedural requirements, tools, materials and methods to be used in the modification, rework, repair, overhaul or restoration of electronic products. Although this document is based in large part on the Product Class definitions used in IPC documents such as J-STD-001 or IPC-A-610, this document should be considered applicable to any type of electronic equipment. When invoked by contract as the controlling document for the modification, rework, repair, overhaul or restoration of products, the requirements flow-down apply.

IPC has identified the most common equipment and process in order to affect a specific repair or rework. It is possible that alternate equipment and processes can be used to make the same repair. If alternate equipment is used, it is up to the user to determine that the resultant assembly is good and undamaged.

1.2.1 Definition of Requirements This document is intended to be used as a guide and there are no specific requirements or criteria unless separately and specifically called out in a user's contractual or other documentation. When statements such as "must," "should" or "need to be" are used, they are stressing an important point. If these strong recommendations are not followed the end result may not be satisfactory and additional damage could be caused.

1.3 Background Today's electronic assemblies are more complex and smaller than ever before. Despite this, they can be successfully modified, reworked or repaired if the proper techniques are followed. This manual is designed to help users repair, rework and modify electronic assemblies with minimum impact on end use function or reliability. The procedures in this document have been obtained from assemblers, printed board manufacturers and users who

recognize the need for documenting commonly used rework, repair and modification techniques. These techniques have, in general, been proven to be acceptable for the class of product indicated through testing and extended field functionality. Procedures contained herein were submitted for inclusion by commercial and military organizations too numerous to list individually. The Repairability Subcommittee has, where appropriate, revised procedures to reflect improvements.

1.4 Terms and Definitions Definitions marked with an * are from IPC-T-50 and apply to the use of this document.

PCA – Printed Circuit Assembly

**Rework* – the act of reprocessing noncomplying articles, through the use of original or equivalent processing, in a manner that assures full compliance of the article with applicable drawings or specifications.

**Modification* – the revision of the functional capability of a product in order to satisfy new acceptance criteria. Modifications are usually required to incorporate design changes which can be controlled by drawings, change orders, etc. Modifications should only be performed when specifically authorized and described in detail on controlled documentation.

**Repair* – the act of restoring the functional capability of a defective article in a manner that does not assure compliance of the article with applicable drawings or specifications.

1.4.1 Class of Product The user of the product is responsible for identifying the Class of Product. The procedure selected for action to be taken (modification, rework, repair, overhaul etc.) must be consistent with the Class identified by the user. The three Classes of Product are:

Class 1 – General Electronic Products

Includes products for applications where the major requirement is the function of the completed assembly.

Class 2 – Dedicated Service Electronic Products

Includes products where continued performance and extended life is required, and for which uninterrupted service is desired but not critical. Typically, the end use environment would not cause failures.

Class 3 – High Performance Electronic Products

Includes products where continued performance or performance-on-demand is critical. Equipment downtime cannot be tolerated, end-use environment may be uncommonly harsh, and the equipment must function where required, such as life support and other critical systems.